

# Videojet 2300

462188-10  
AA, 2010 5

2010 5 Videojet Technologies

Videojet

Videojet Technologies  
Videojet

Videojet  
CLARiTY® CLARiSOFT® CLARiNET®

---

**Videojet Technologies**

1500 Mittel Boulevard  
Wood Dale, IL  
60191-1073 USA  
[www.videojet.com](http://www.videojet.com)

1-800-843-3610  
1-800-582-1343  
630-616-3629

-

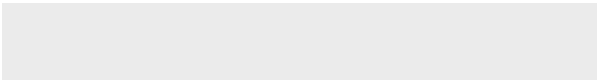

FCC 15

1)

2)

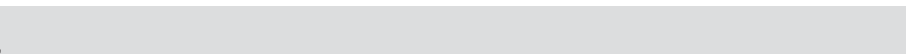

FCC 15 A

FCC A



### **Pour la Clientèle du Canada**

Le present appareil numerique n'emet pas de bruits radioelectriques depassant les limites applicales aux appareils numerique de las class A prescrites dans le Reglement sur le brouillage radioelectrique edicte par le ministere des Communications du Canada.

Cet équipement est certifié CSA.

#### **CE**

##### **EU EMC 2004/108/EC**

EN61000-6-2:2005

BS EN 55022:1998 +A1 2000  
+A2 2003 A

IT

BS EN 55024:1998+A1 2001  
+A2 2003

IT

EN61000-3-2:2000

16A

EN61000-3-3:1995 +A1 2001

16A

##### **EC 2006/95/EEC**

EN60950-1:2006 IEC  
60950-1:2005

1-800-843-3610

Videojet Technologies  
Videojet Technologies

**Videojet Technologies**  
1500 Mittel Boulevard  
Wood Dale, IL 60191-1073 U.S.A.  
1-800-843-3610  
1-800-582-1343  
630-616-3629  
[www.videojet.com](http://www.videojet.com)

***Total Source***

*Total Source*® TOTAL SERVICE PLUS RELIABILITY  
Videojet Technologies

***Total Source***

Videojet *Total Source*®

- 
- 
- 
- 
- 
- 
- 
- 
- 
-

Videojet Technologies

*Videojet Technologies*

Videojet Technologies  
1-800-843-3610  
Videojet                      Videojet

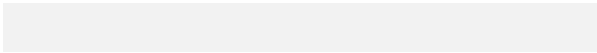

..... *i*  
 ..... *i*  
*Pour la Clientèle du Canada* ..... *ii*  
 ..... *ii*

..... *iii*  
 ..... *iii*  
 ..... *iv*

**1** —  
 Videojet 2300 ..... 1-1  
 ..... 1-1  
 ..... 1-2

**2** —  
 ..... 2-1  
 ..... 2-2  
 ..... 2-2  
 ..... 2-2  
 ..... 2-3  
 ..... 2-4  
 ..... 2-4  
 2300 ..... 2-6  
 ..... 2-6  
 / ..... 2-7  
 ..... 2-9  
 ..... 2-10  
 ..... 2-10

**3** — **CLARITY®**  
 ..... 3-1  
 CLARITY® ..... 3-2  
 ..... 3-2  
 ..... 3-2  
 ..... 3-5

**4 —**

.....4-1

.....4-4

.....4-5

LED .....4-6

.....4-6

.....4-6

.....4-7

.....4-11

.....4-13

.....4-14

'A' .....4-15

'B' .....4-15

**5 —**

.....5-1

.....5-1

.....5-5

.....5-5

.....5-6

.....5-9

/ .....5-10

.....5-11

.....5-13

.....5-14

.....5-18

.....5-20



## Videojet 2300

Videojet 2340 2350 2360

2300 CLARiTY®

(PC)

PC

2300

1-1

Videojet 2340	17	X 2000
Videojet 2350	50	X 2000
Videojet 2360	70	X 2000

1-1

*Videojet 2300*

" "

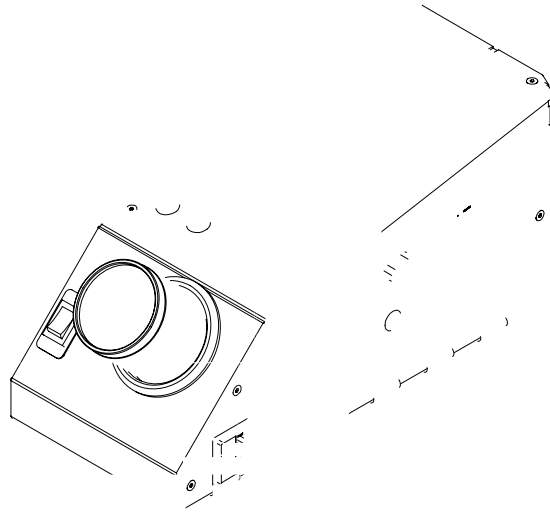

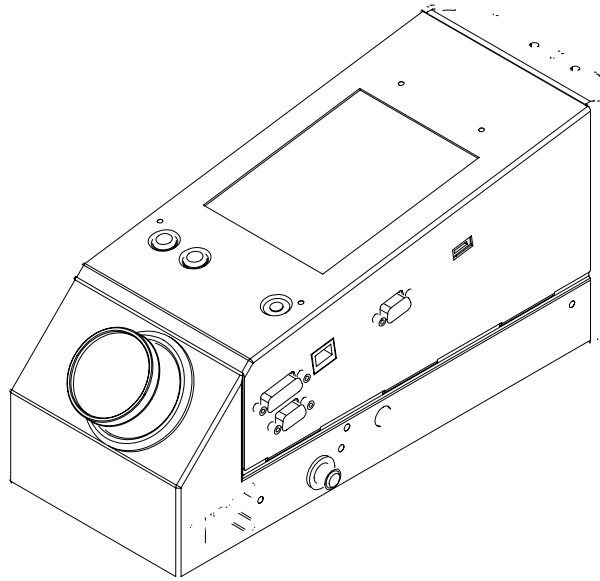

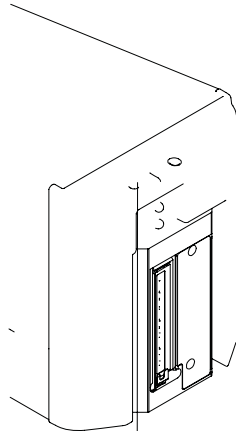

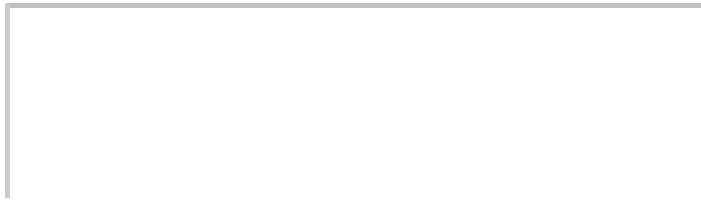

- 
- 
- 
- 
- 
- 2003
- 
- 



Videojet Technologies  
/

- 
- 
- " "
- 



" "

- 
- - 
  - " "
  -



AC OFF (O)  
OFF





---

ANSI/NFPA 70-1993 500

MSDS



56°C (133°F) Videojet -22°C (-8°F)

---







15





(MSDS)

MSDS  
MSDS

MSDS

MSDS  
800-843-3610  
Videojet

Videojet  
Videojet

---



MSDS

---

**2300**

/



60947-3 IEC 60947-2

IEC



Videojet 2340 2350 2360

" "





Videojet 2340 2350 2360

-

/

---



/

---



Videojet 2340/2350/2360

---



---

/ MSDS

- CLARITY<sup>®</sup>
- 
- 

CLARITY<sup>®</sup>



# CLARITY®

CLARITY®

3-1

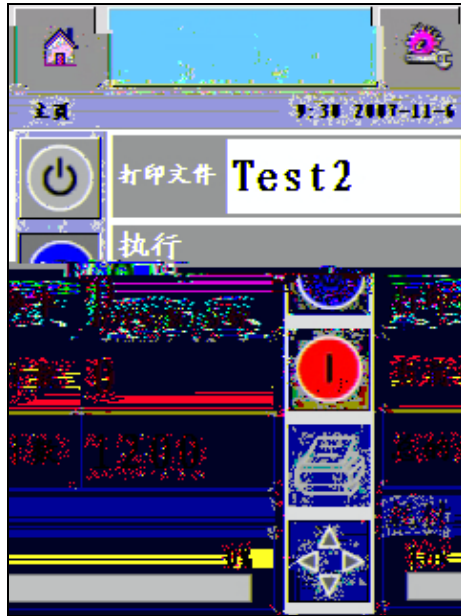

3-1 CLARITY®

3-2

3-3

3-1



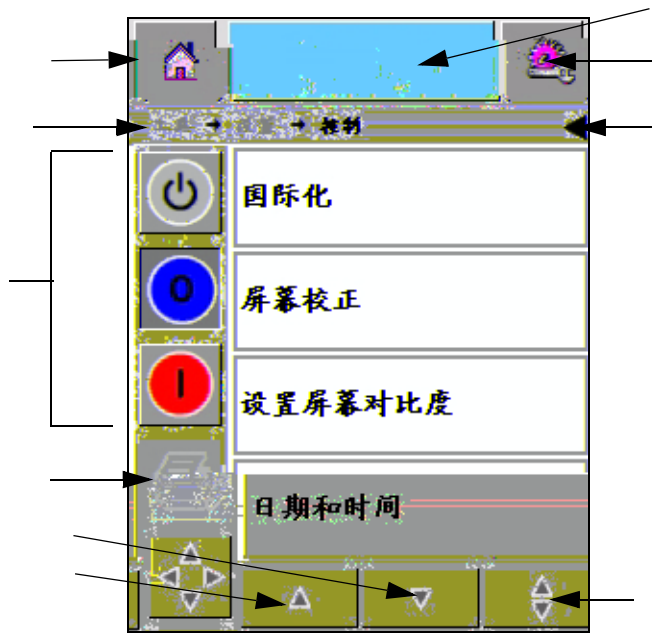

3-2

	Videojet 2340/2350/2360
	3-4 " "
	<ul style="list-style-type: none"> <li>•</li> <li>•</li> </ul>

3-1



CLARITY®

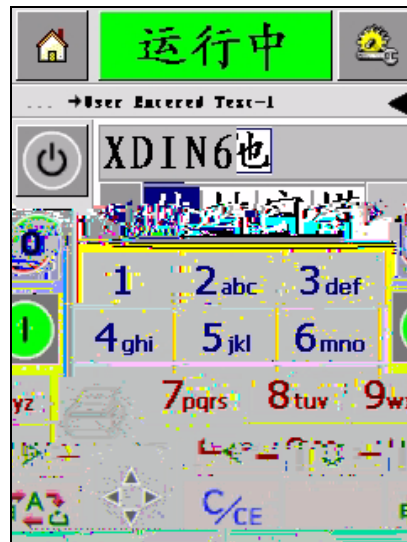

3-5

3-2

1	1...?!-!-&;+#()'"_@\$£€¥%<>¿¡\$=α
2	ABC2abcÄÅÂÃÄÅÆÇäåääãääæçø
3 def	DEF3defÈÉÊËÈèéê€
4 ghi	GHI4ghiİıİiı
5 jkl	JKL5jkl£
6 mno	MNO6mnoÖÛÔÓØÑöðóøñ

3-2

-

	PQRS7pqrs\$B\
	TUV8tuvÛÛÛÛÛÛÛÛ
	WXYZ9wxyz
	0*
	/

3-2

-



- 
- 
- 
- LED
- 
- 
- 

4-1

4-2

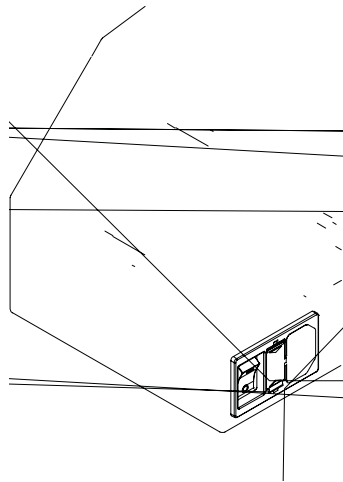

1

90

2

CLARITY®

3

CLARITY®

4-3

4-3

4



4-3

5

4-3



2300

4-1

Videojet 2340	2.5
Videojet 2350	3.5
Videojet 2360	4.5

4-1



4-4

Videojet 2340 2350 2360



/

/

- 
- 
- 

CLARITY®

4-5

4-5

-

# LED

CLARITY®  
4-6

LED



LED

4-6 LED

LED 4-2

LED	
	LED
	CLARITY®

4-2 LED

- 
- 
- 

4-7

4-7

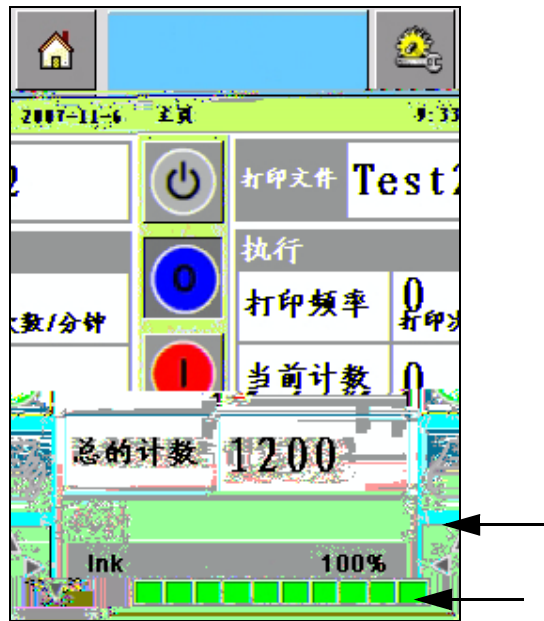

4-7



4-3

5% CLARITY®  
4-7

4-4

	175	365
Videojet 2340	M512-4	
Videojet 2350	M512-4	M512-K
Videojet 2360	M512-4	M512-K

4-4

1

4-7

4-7

4-8



4-8

2

4-8

4-9

4-9

3



4-9

4

" "

4-10

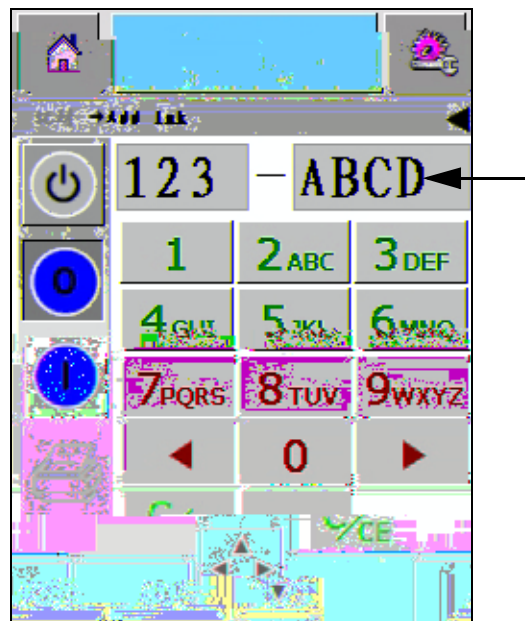

4-10

4-10

4-11



4-11



## 5 CLARITY®

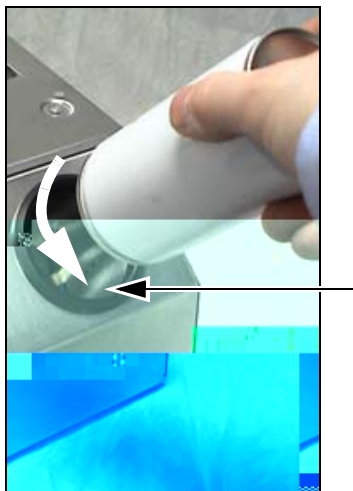

4-12

- a.
- b.
- c.

4-13



4-13

1

4-12

4-11

4-15

4-14

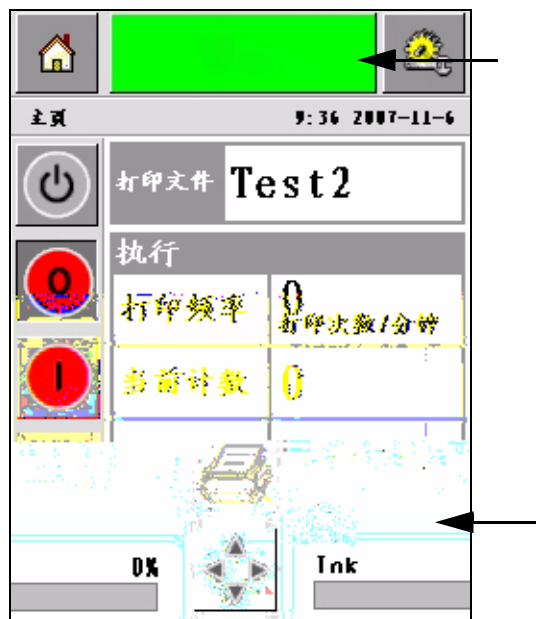

4-14

2



4-15

3

4-16

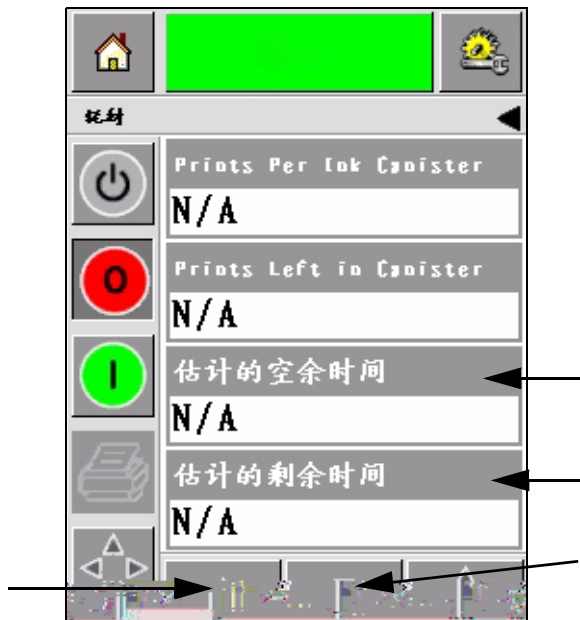

4-16



- 
- 
- 
- 
- 

2300

4-5

		100%
Videojet 2340	10 / 0.6 /	550 / 33 / )
Videojet 2350	10 / 0.6 /	550 / 33 / )
Videojet 2360	10 / 0.6 /	550 / 33 / )

4-5

- 
- 
- 
- 

-  
-

2

4-17

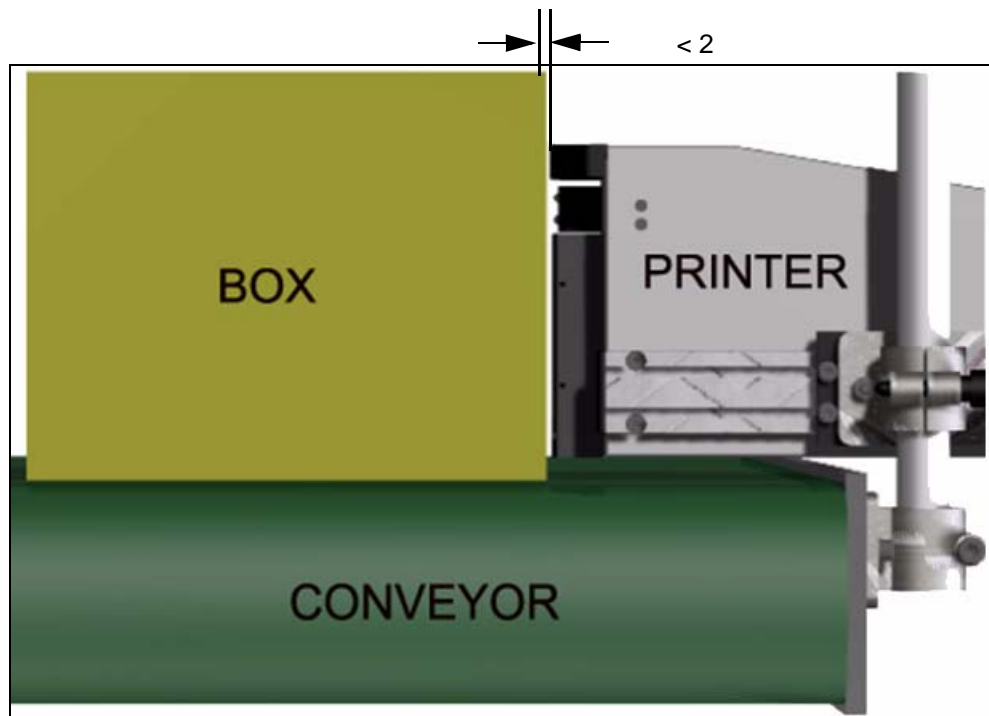

4-17

4-18      **A**   **B**      4-19

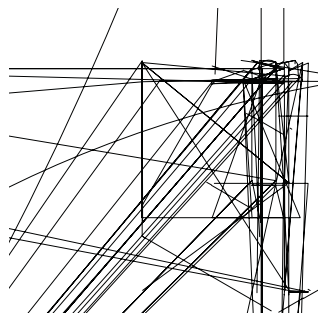

'A'



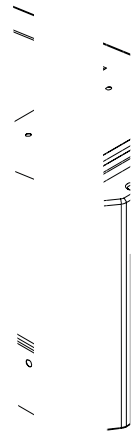
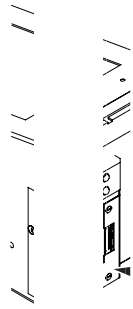

"

"



# 5



- 
- 
- 
- 
- 
- 
- 
- 
- 

/

5-6

5-5

1

5-2

5-1

5-2

5-2



5-1

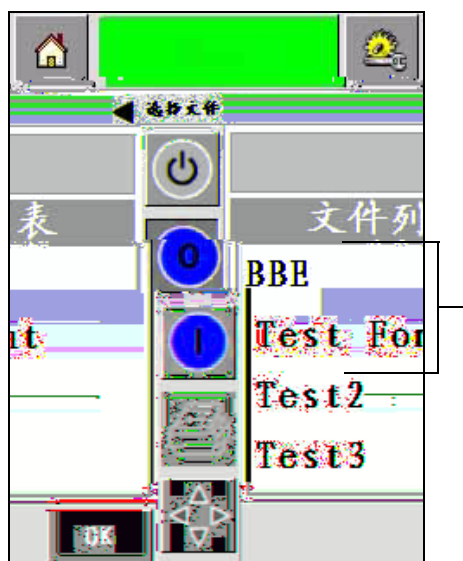

5-2

---

2

5-3

3

•

5-4

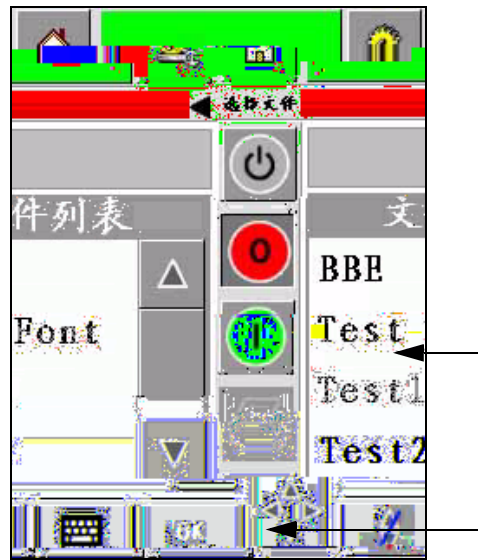

5-4



5-5



4

CLARITY®

5-6



5-6

5

5-6

6

5-6

"

"

CLARITY®

CLARITY®

5-6

5-7

CLARITY®

5-7



2

5-8

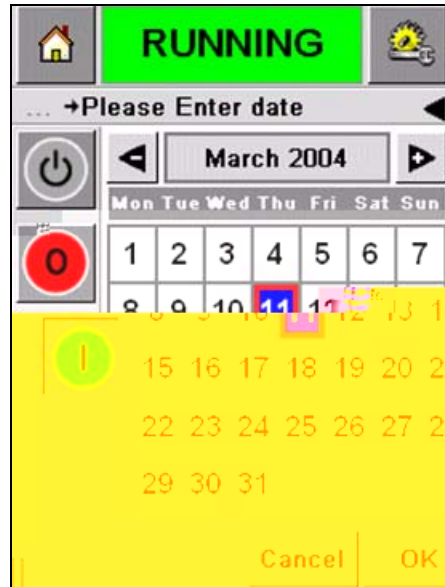

5-8

- 
- 

5-8

3

4 CLARITY®

5-8

5-9



5-9

5

5-10



5-10

6

5-11



5-11

2340/2350/2360

5-12

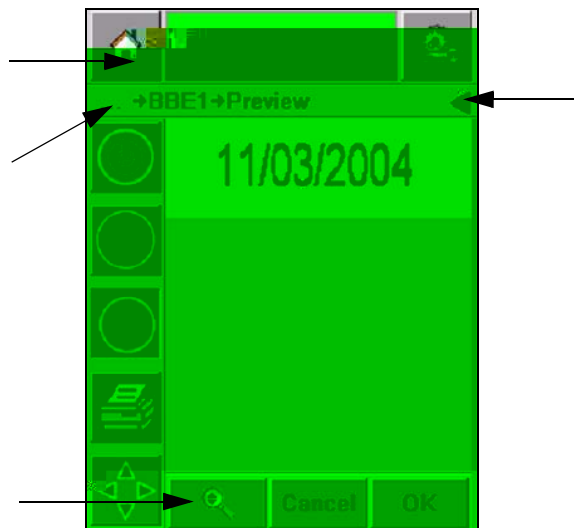

5-12

5-12

/

5-13

5-13

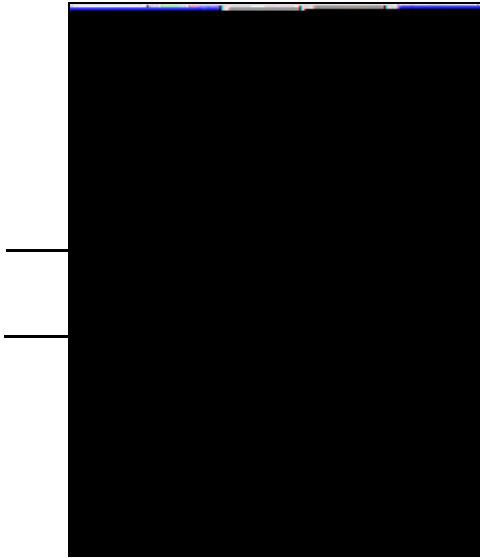

5-13

- 
- 
- 
- 

**A B**

4-14

"

"

/

1

> >

5-14



5-14

2

5-12

5-15



- 

5-12

5-16

- 

5-13

5-17

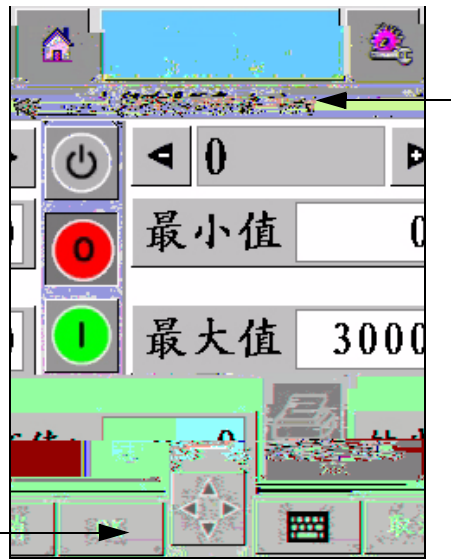

5-15



5-16





5-17

3

2340/2350/2360

10

1 > >  
5-18

2

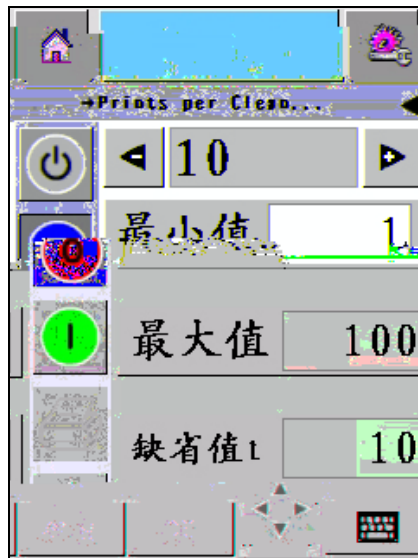

5-18

CLARITY®

5-14

5-19



5-19

CLARITY®

5-19

CLARITY®

5-15

5-20



5-20



CLARITY®

5-21

5-21

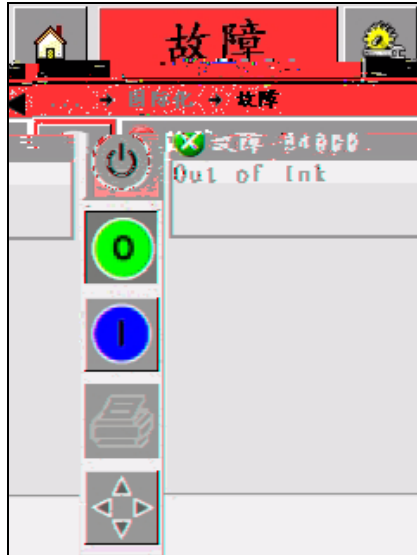

5-21

CLARITY®

LED

CLARITY®

5-17

5-22

CLARITY®

5-17

5-22



# CLARITY®

1

> >

5-23



5-23

2

5-23

3

5-19

5-24

4



5

6

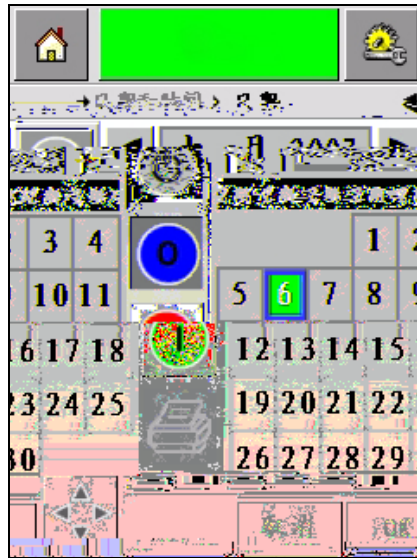

5-24

7

5-25

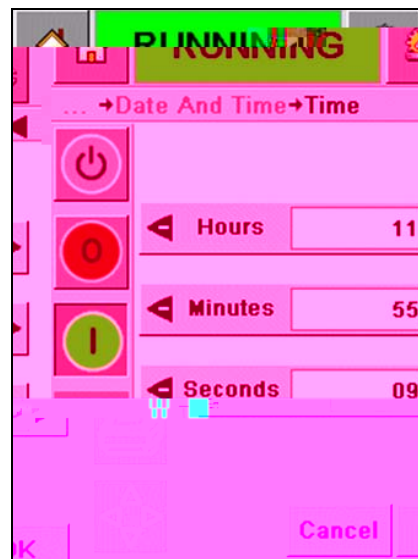

5-25



8

9

10

CLARITY®

Month Day Year

Day Month Year

1

> > >

5-26



5-26

2

5-21

5-27





5-27

3

4 /

5-20

5-26

5

5-28



5-28 /

6

7